

ESD Protection Diodes

Low Capacitance Bidirectional ESD and Transient Voltage Protection

SD0520D52L SOD523



Pinout and Functional Block Diagram

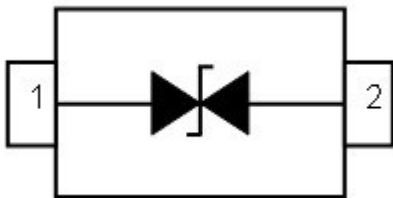

Applications

- Microprocessor based equipment
- Cell Phone Handsets and Accessories
- Personal Digital Assistants (PDA's)
- Notebooks, Desktops, and Servers
- Portable Instrumentation
- Networking and Telecom
- Serial and Parallel Ports
- Peripherals
- Pagers

Order Information

Type	Package	Marking Code	Delivery Form	Delivery Quantity
SD0520D52L	SOD523	OC	7" T&R	3000 PCS

Description

The SD0520D52L is designed to protect voltage sensitive component from ESD and transient voltage events. Excellent clamping capability, low leakage, and fast response time, make these parts ideal for ESD protection on designs where board space is at a premium. Because of its small size, it is suited for use in cellular phones, portable devices, digital cameras, power supplies and many other portable applications where board space comes at a premium. Also because of its low capacitance, it is suited for use in high frequency designs such as high speed line application.

This device has been specifically designed to protect sensitive components which are connected to data and transmission lines from overvoltage caused by ESD (electrostatic discharge), and EFT (electrical fast transients).

Features

- ESD Per IEC 61000-4-2 ± 30 kV (Contact)
- ESD Per IEC 61000-4-2 ± 30 kV (Air)
- IEC61000-4-4 (EFT) 40 A (5 / 50 ns)
- Peak Power Dissipation: 400 W (8 / 20 μ s)
- Protects One Vcc or Data Line
- Low Clamping Voltage
- Low Leakage Current
- Low Capacitance
- High Temperature to Reflow Soldering Guaranteed: 260 $^{\circ}$ C / 10 sec
- Flammability Rating: UL 94 V-0
- Halogen Free and RoHS Compliant

ESD Protection Diodes

Low Capacitance Bidirectional ESD and Transient Voltage Protection

SD0520D52L SOD523

Package Dimensions - SOD523

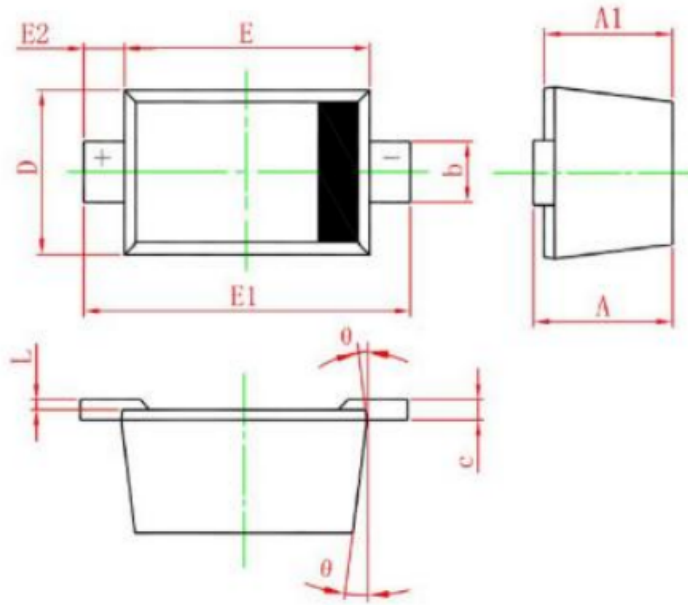

Symbol	Millimeters		Inches	
	Min.	Max.	Min.	Max.
A	0.51	0.77	0.020	0.031
A1	0.50	0.70	0.020	0.028
b	0.25	0.35	0.010	0.014
c	0.08	0.15	0.003	0.006
D	0.70	0.90	0.028	0.035
E	1.10	1.30	0.043	0.051
E1	1.50	1.70	0.059	0.067
E2	0.20 REF		0.008 REF	
L	0.01	0.07	0.001	0.003
φ	7 ° REF		7 ° REF	

Limiting Values

(T_A = 25 °C, unless otherwise specified)

Symbol	Parameter	Conditions	Min	Max	Unit
V _{ESD}	Electrostatic Discharge Voltage	IEC 61000-4-2; Contact Discharge	-	30	kV
		IEC 61000-4-2; Air Discharge	-	30	kV
P _{PP}	Peak Pulse Power (8 / 20 μs)	-		400	W
T _A	Operating Temperature Range	-	-55	125	°C
T _{stg}	Storage Temperature Range	-	-55	150	°C

Electrical Characteristics

($T_A = 25\text{ }^\circ\text{C}$, unless otherwise specified)

Symbol	Parameter	Conditions	Min	Typ	Max	Unit
V_{RWM}	Reverse Working Voltage	-	-	-	5.0	V
V_{BR}	Reverse Breakdown Voltage	$I_T = 1\text{ mA}$	5.8	-	7.8	V
I_R	Reverse Leakage Current	$V_{RWM} = 5\text{ V}$	-	-	1.0	μA
V_C	Clamping Voltage	$I_{PP} = 1\text{ A}$, $t_p = 8 / 20\ \mu\text{s}$	-	-	9.8	V
V_C	Clamping Voltage	$I_{PP} = 20\text{ A}$, $t_p = 8 / 20\ \mu\text{s}$	-	15	20	V
C_J	Junction Capacitance	$V_R = 0\text{ V}$, Measured at 1 MHz	-	33	40	pF

Performance Curve for Reference

($T_A=25\text{ }^\circ\text{C}$ unless otherwise noted)

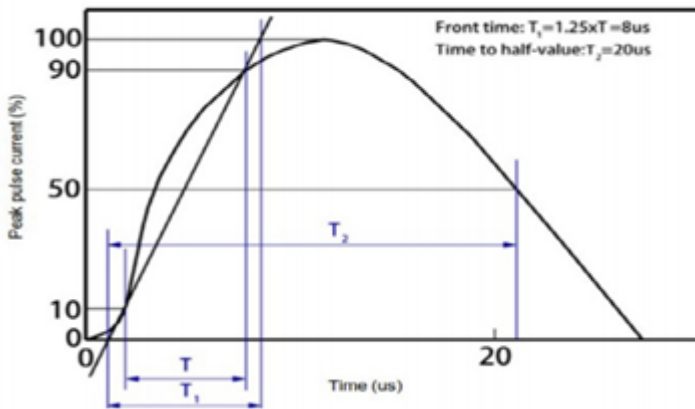

FIGURE 1

8 / 20 μs Waveform Per IEC61000-4-5

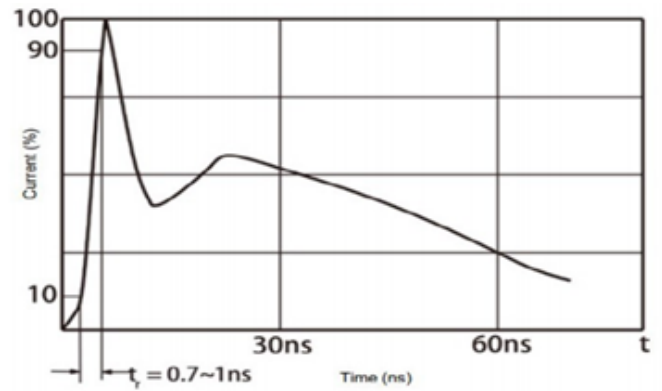

FIGURE 2

Contact Discharge Current Waveform Per IEC 61000-4-2

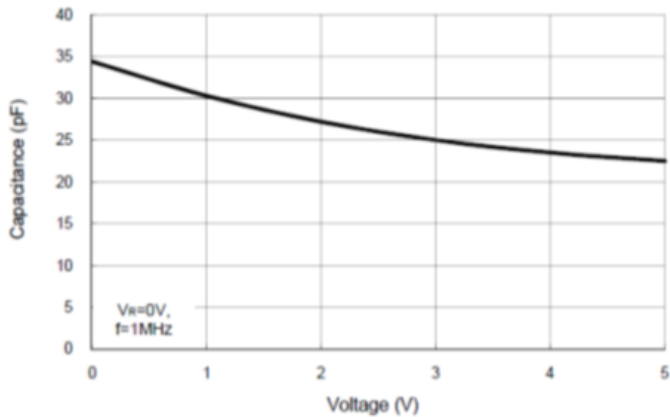

FIGURE 3

Voltage VS. Capacitance

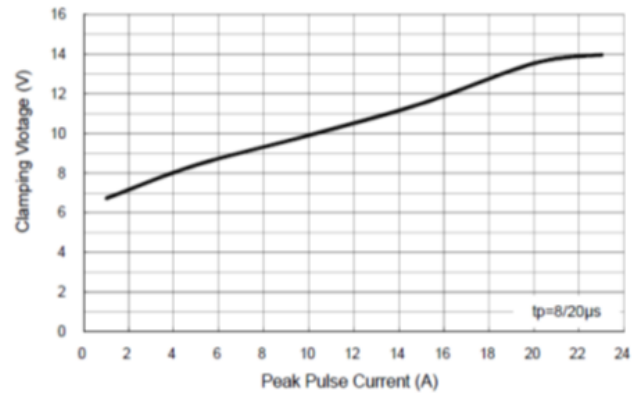
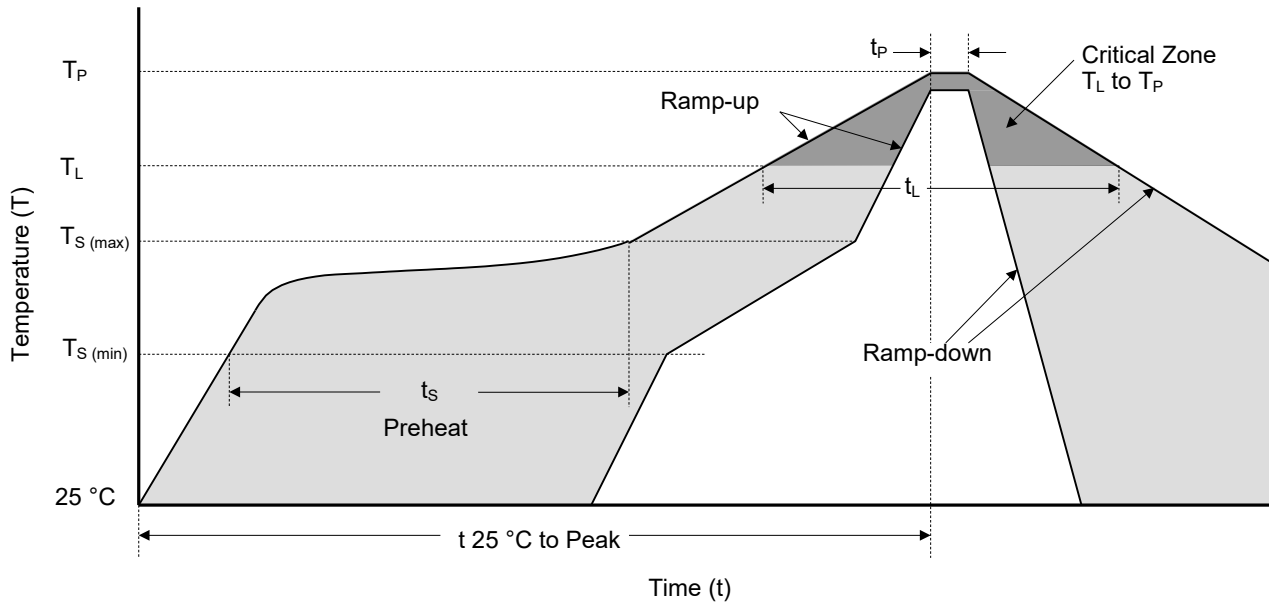

FIGURE 4

Clamping Voltage VS. Peak Pulse Current

Soldering Parameters



Reflowing Condition

Reflow Soldering Parameters		Lead-Free Assembly
Pre-heat	Temperature Min ($T_{S (min)}$)	150 °C
	Temperature Max ($T_{S (max)}$)	200 °C
	Time (min to max) (t_s)	60 ~ 120 seconds
Average Ramp Up Rate (Liquidus Temp (T_L) to Peak)		3 °C / second max.
$T_{S (max)}$ to T_L Ramp-up Rate		3 °C / second max.
Reflow	Temperature (T_L) (Liquidus)	217 °C
	Time (min to max) (t_L)	60 ~ 150 seconds
Peak Temperature (T_P)		260 ^{+0/-5} °C
Time of within 5 °C of Actual Peak Temperature (t_p)		20 ~ 40 seconds
Ramp-down Rate		6 °C / second max.
Time from 25 °C to Peak Temperature		8 Minutes max.
Do Not Exceed		260 °C



ATTENTION

Usage

1. TVS must be operated in the specified ambient temp.
2. Do not clean the TVS with strong polar solvent such as ketone, esters, benzene and halogenated hydrocarbon, to avoid damaging the encapsulating layer.
3. Please do not apply severe vibration, shock or pressure to TVS, to avoid element cracking.

Replacement

1. If TVS is visually damaged, please replace it.
2. TVS is a non-repairable product. For safety sake, please use equivalent TVS for replacement.

Storage

1. Storage Temp. Range: (-55 to 150) °C.
2. Do not store the TVS at the high temp., high humidity or corrosive gas environment, to avoid influencing the solder-ability of the lead wires. The product shall be used up within 1 year after receiving the goods.

Environmental Conditions













































1. TVS should not be exposed to the open air, nor direct sunshine.
2. TVS should avoid rain, water vapor or other condition of high temp. and high humidity.
3. TVS should avoid sand dust, salt mist, or other harmful gases.

Max. Typical Capacitance of TVS

The typical capacitance of TVS is listed in the specifications. Designers may refer to it when designing TVS in High frequency circuit.

Installation Mechanical Stress

1. Do not knock TVS when installing, to avoid mechanical damage.
2. Please do not apply severe vibration, shock or pressure to TVS, to avoid surface resin or element cracking.

Package Outline					Circuit Diagram					
										
DFN0603	DFN1006	DFN1006-3L	DFN1610	DFN2020-3L	1CH/UNI	1CH/BI	2CH/UNI	2CH/BI	1CH/BI	1CH/UNI
										
DFN1610-6L	DFN2010-8L	DFN2510	DFN2626-10L	DFN3810-9L	1CH/UNI	1CH/BI	1CH/UNI	1CH/BI	2CH/UNI	2CH/BI
										
SOD-923	SOD-523	SOD-323	SOD-123	SOT-143	1CH/UNI	2CH/UNI	2CH/UNI	4CH/UNI	5CH/UNI	4CH/UNI
										
SOT-523	SOT-323	SOT-23	SOT-363	SOT-23-6L	2CH/BI	4CH/UNI	4CH/UNI	8CH/UNI	8CH/UNI	8CH/UNI